

Part Number: APT1608PBC/A

Blue



ATTENTION
OBSERVE PRECAUTIONS
FOR HANDLING
ELECTROSTATIC
DISCHARGE
SENSITIVE
DEVICES

Features

- 1.6mmX0.8mm SMT LED, 0.75mm THICKNESS.
- LOW POWER CONSUMPTION.
- WIDE VIEWING ANGLE.
- IDEAL FOR BACKLIGHT AND INDICATOR.
- VARIOUS COLORS AND LENS TYPES AVAILABLE.
- PACKAGE: 2000PCS / REEL .
- MOISTURE SENSITIVITY LEVEL : LEVEL 3.
- RoHS COMPLIANT.

Description

The Blue source color devices are made with InGaN on SiC Light Emitting Diode.

Static electricity and surge damage the LEDs.

It is recommended to use a wrist band or anti-electrostatic glove when handling the LEDs.

All devices, equipment and machinery must be electrically grounded.

Package Dimensions

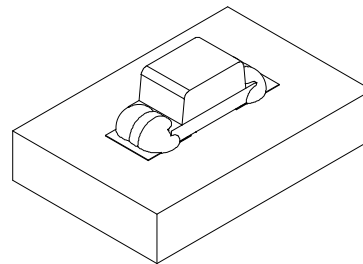
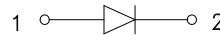
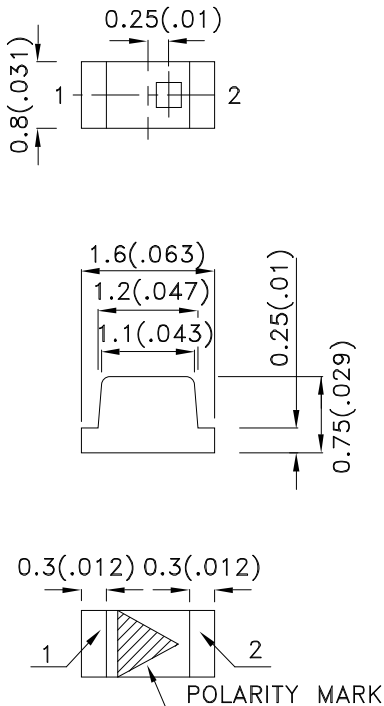

Notes:

1. All dimensions are in millimeters (inches).
2. Tolerance is $\pm 0.1(0.004)$ unless otherwise noted.
3. Specifications are subject to change without notice.
4. The device has a single mounting surface. The device must be mounted according to the specifications.



Selection Guide

| Part No. | Dice | Lens Type | Iv (mcd) [2] @ 20mA | | Viewing Angle [1] |
|--------------|--------------|-------------|------------------------|------|----------------------|
| | | | Min. | Typ. | 2θ1/2 |
| APT1608PBC/A | Blue (InGaN) | WATER CLEAR | 18 | 60 | 120° |

Notes:

1. θ1/2 is the angle from optical centerline where the luminous intensity is 1/2 the optical centerline value.
2. Luminous intensity/ luminous Flux: +/-15%.

Electrical / Optical Characteristics at TA=25°C

| Symbol | Parameter | Device | Typ. | Max. | Units | Test Conditions |
|--------------------|--------------------------|--------|------|------|-------|---------------------------|
| λ _{peak} | Peak Wavelength | Blue | 468 | | nm | I _F =20mA |
| λ _D [1] | Dominant Wavelength | Blue | 470 | | nm | I _F =20mA |
| Δλ _{1/2} | Spectral Line Half-width | Blue | 21 | | nm | I _F =20mA |
| C | Capacitance | Blue | 100 | | pF | V _F =0V;f=1MHz |
| V _F [2] | Forward Voltage | Blue | 3.2 | 4 | V | I _F =20mA |
| I _R | Reverse Current | Blue | | 10 | uA | V _R =5V |

Notes:

1. Wavelength: +/-1nm.
2. Forward Voltage: +/-0.1V.

Absolute Maximum Ratings at TA=25°C

| Parameter | Blue | Units |
|--------------------------|----------------|-------|
| Power dissipation | 120 | mW |
| DC Forward Current | 30 | mA |
| Peak Forward Current [1] | 100 | mA |
| Reverse Voltage | 5 | V |
| Operating Temperature | -40°C To +85°C | |
| Storage Temperature | -40°C To +85°C | |

Note:

1. 1/10 Duty Cycle, 0.1ms Pulse Width.



Blue

APT1608PBC/A

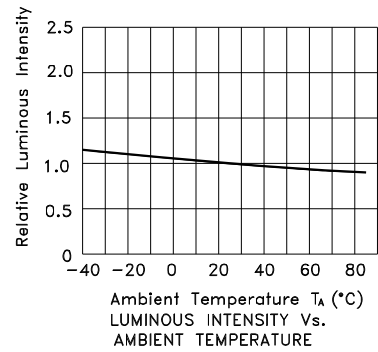
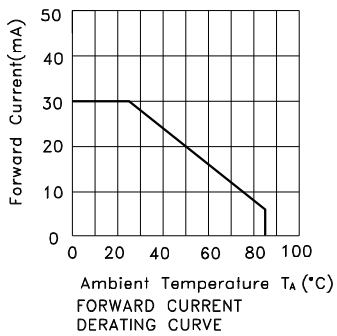
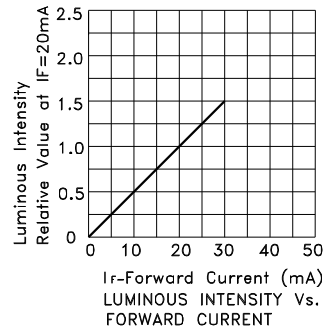
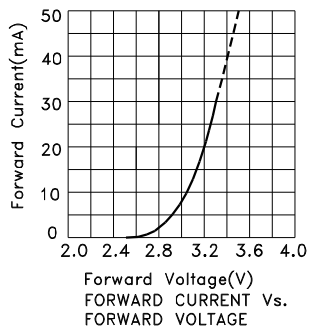

APT1608PBC/A

Reflow Soldering Profile For Lead-free SMT Process.



NOTES:

1. We recommend the reflow temperature 245°C(+/-5°C). The maximum soldering temperature should be limited to 260°C.
2. Don't cause stress to the epoxy resin while it is exposed to high temperature.
3. Number of reflow process shall be 2 times or less.

Recommended Soldering Pattern (Units : mm; Tolerance: ± 0.1)

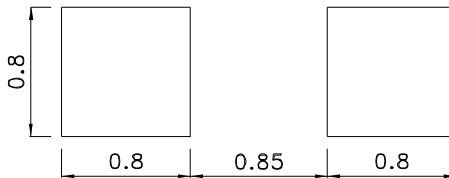

Tape Specifications (Units : mm)

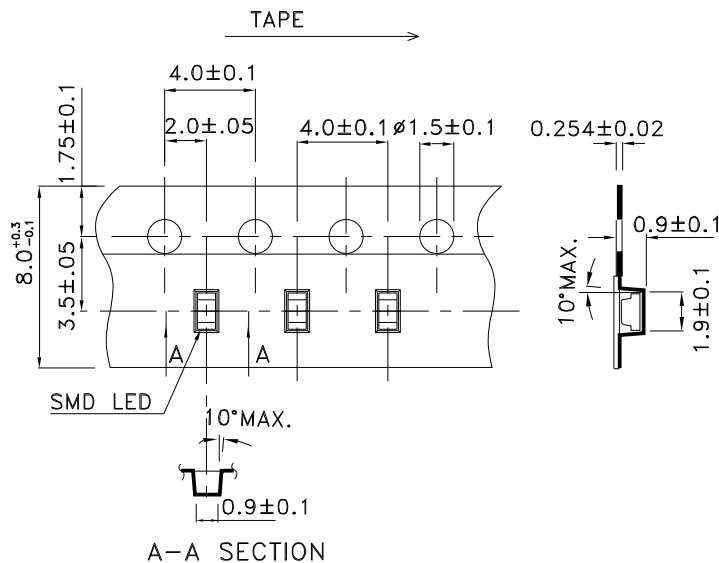

PACKING & LABEL SPECIFICATIONS

APT1608PBC/A

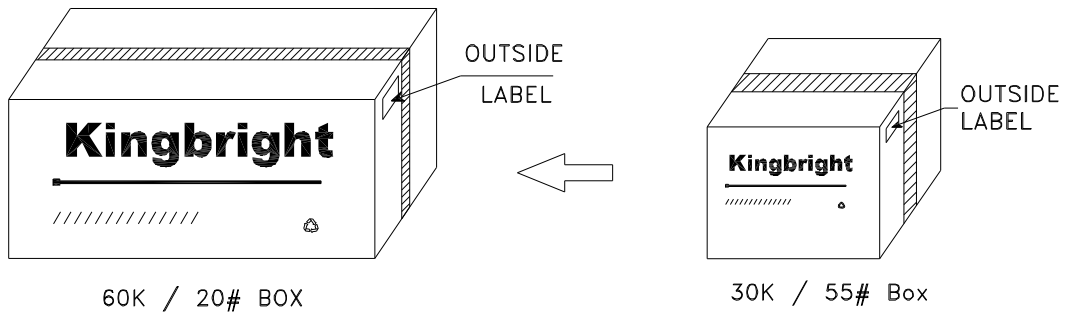
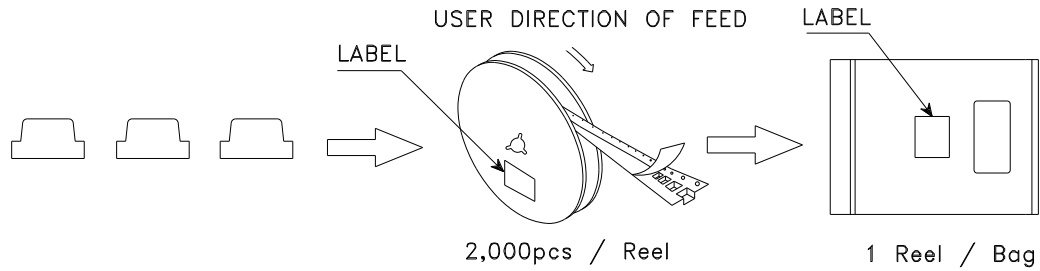

| | |
|---|--|
| <h2 style="margin: 0;">Kingbright</h2> | |
| P/NO: APT1608xxx | |
| QTY: 2,000 pcs | Q.C. Q C xx xx xxxx PASSED |
| S/N: XXXX | |
| CODE: XXX | |
| LOT NO: | |
| <small>XXXXXXXXXXXXXXXXXXXXXXXXXXXX</small> | |
| RoHS Compliant | |